

Receptáculo montado en panel - Pieza no. 1463

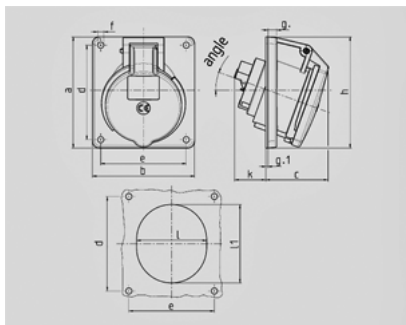

- terminales de tornillo
- adecuado para cableado pasante
- Inclinación de 20 °

Información técnica	
Amperio	16 A
Polos	3 p
voltaje	230 V
Posición de la tierra	6 h
Hertz	50-60 Hz
Tecnología de conexión	Terminales de tornillo
Contacto	estándar
Tipo de protección	IP 44



Drawing 1 MB 260 Dim. in mm	Amp. Poles	16			32		
		3	4	5	3	4	5
a		73.5	100	100	100	100	100
b		64	92	92	92	92	92
c		50	59	58	62	62	61
d		60	85	85	85	85	85
e		52	77	77	77	77	77
f		5.5	5.5	5.5	5.5	5.5	5.5
g		7	8	8	8	8	8
g-1		2	2	2	2	2	2
h		79	100	100	103	103	106
k		44	34	34	54	54	49
l		52	55	65	67	67	72
ll		60	63	72	82	82	85
o		20°	20°	20°	20°	20°	20°
Terminal for cond. cross section (mm ²) min.-max.		1.5	1.5	1.5	2.5	2.5	2.5
		-4	-4	-4	-10	-10	-10