

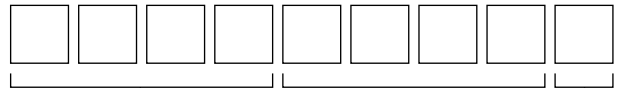

C025... / C032... / C040... CX25... / CX32... / CX40...

**TAMAÑOS DE LOS INTERRUPTORES
DE LEVA: 25 A / 32 A / 40 A**

Lectura de códigos



Esquema eléctrico
del interruptor de
leva (ver p.9)

Serie de interruptores de
leva (esta ficha técnica)

	C025...	CX25...
	C032...	CX32...
	C040...	CX40...
Especificaciones	p.2	p.2

Clase de
protección de
los terminales



IP20



IP10

R
Panel trasero
montaje



p.5



p.6

B
Montaje en la
base



p.7



p.8

Tipo de montaje del interruptor de leva

Ejemplo de código

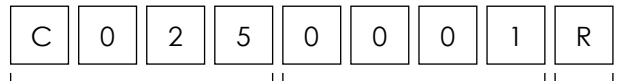

Interruptor de leva

Esquema eléctrico del interruptor de leva

Tipo de montaje del interruptor de leva

VER ACTUADORES DISPONIBLES EN p.15

ESPECIFICACIONES

Características generales

Grado de protección	control	EN 60529 UL50 / NEMA	IP65 Tipo 1 - 4 - 4X
	mando sólo con botón giratorio		IP40
	terminales		C025... / C032... / C040... CX25... / CX32... / CX40... IP20 IP10
Grupo de materiales		EN 60947-1	II
Grado de contaminación		EN 60947-1	3
Flamabilidad		UL94	V0 (piezas eléctricas bajo tensión)
Temperatura ambiente	funcionamiento almacenaje		-40 ... +85°C -40 ... +70°C
Resistencia al clima		IEC 68 part 2-3 IEC 68 part 2-30	calor húmedo, estado estacionario calor húmedo, cíclico
Identificación de los bornes	conforme a		EN50013
Conexiones	bloque terminal calibre	EN60947-1	A5
	ttornillo del terminal		M4
	torque de apriete	EN60947-1 UL508	1.2 N·m (10.6 lb·in) 12 lb·in (1.4 N·m)
Sección conectable	conductores flexibles		2 × 2.5 ... 10 mm ² AWG 14 ... 6
	conductores solidos		2 × 2.5 ... 10 mm ² AWG 14 ... 6
Contactos			doble ruptura
Ángulos de apertura			30° - 45° - 60° - 90°
Vida útil mecánica	@ 120 operaciones / hora		1 millón de ciclos
Vida útil eléctrica	@ 120 operaciones / hora		C025... / CX25... 1 millón de ciclos C032... / CX32... 0.75 millón de ciclos C040... / CX40... 0.75 millón de ciclos

Características EN 60947-3

		C025... / CX25...	C032... / CX32...	C040... / CX40...
Tensión nominal de funcionamiento	Ue	690 V	690 V	690 V
Tensión nominal de aislamiento	Ui	690 V	690 V	690 V
Tensión nominal soportada a impulsos (seccionable)	Uimp	6 kV	6 kV	6 kV
Corriente térmica nominal	Ith	32 A	40 A	50 A
Corriente térmica nominal cerrada	Ithe	25 A	32 A	40 A
Frecuencia		50/60 Hz	50/60 Hz	50/60 Hz

Corriente Alterna

Corriente nominal de funcionamiento		le	C025... / CX25...		C032... / CX32...		C040... / CX40...	
AC-21A Conmutación de cargas resistivas, incluidas las sobrecargas moderadas		690 V	25 A		32 A		40 A	
AC-22A Conmutación de cargas mixtas resistivas e inductivas, incluidas sobrecargas moderadas		690 V	25 A		32 A		40 A	
AC-23A Conmutación de cargas de motor u otras cargas altamente inductivas	1 fase - 1 polo	110 V	25 A	1.5 kW	30 A	2.2 kW	35 A	3 kW
		230 V	25 A	4 kW	30 A	5.5 kW	35 A	6.5 kW
	3 fases - 3 polos	230 V	25 A	7.5 kW	30 A	9 kW	35 A	11 kW
		400 V	22 A	11 kW	24 A	15 kW	32 A	18.5 kW
		500 V	22 A	11 kW	27 A	18.5 kW	32 A	22 kW
690 V	20 A	15 kW	22 A	18.5 kW	25 A	22 kW		
AC-3 Motores de jaula de ardilla: arranque, apaga los motores durante el tiempo de funcionamiento	1 fase - 1 polo	110 V	22 A	1.1 kW	25 A	1.5 kW	30 A	2.5 kW
		230 V	22 A	3.7 kW	25 A	4 kW	30 A	5.5 kW
	3 fases - 3 polos	230 V	18 A	5.5 kW	23 A	7.5 kW	27 A	9 kW
		400 V	18 A	7.5 kW	23 A	11 kW	27 A	15 kW
		500 V	18 A	11 kW	23 A	15 kW	27 A	18.5 kW
690 V	14 A	11 kW	18 A	15 kW	20 A	18.5 kW		
AC-23A Capacidad nominal de rotura ($\cos\phi$ 0,45)		230 V	200 A		240 A		280 A	
		400 V	176 A		216 A		256 A	
		500 V	176 A		216 A		256 A	
		690 V	160 A		176 A		200 A	

Corriente Continua

Corriente nominal de funcionamiento		le	C025... / CX25...		C032... / CX32...		C040... / CX40...	
DC-21A Conmutación de cargas resistivas con sobrecargas ligeras		1 fase	50 V	20 A *	25 A *	32 A *		
DC-22A Conmutación de cargas resistivas con sobrecargas ligeras		1 fase	30 V	16 A *	20 A *	25 A *		

* Valores no consignados en los ficheros IMQ.

Características de cortocircuito

		C025... / CX25...	C032... / CX32...	C040... / CX40...
Corriente nominal soportada de cortocircuito de corta duración (1 s) I _{cw}		500 A	500 A	500 A
Capacidad nominal de cortocircuito	I _{cm}	2840 A	2840 A	2840 A
Corriente nominal condicional de resistencia al cortocircuito		10 kA	10 kA	10 kA
Capacidad del fusible (tipo gG)	500 V	40 A	40 A	40 A

Características UL 508

			C025... / CX25...	C032... / CX32...	C040... / CX40...
Uso general		600 V AC	25 A	32 A	20 A
Carga estándar del motor	1 fase - 2 polos	120 V AC	1.5 HP 20 FLA	2 HP 24 FLA	3 HP 34 FLA
		240 V AC	3 HP 17 FLA	5 HP 28 FLA	5 HP 28 FLA
	3 fases - 3 polos	200 V AC	7.5 HP 25.3 FLA	7.5 HP 25.3 FLA	10 HP 32.2 FLA
		240 V AC	7.5 HP 22 FLA	7.5 HP 22 FLA	10 HP 28 FLA
		480 V AC	15 HP 21 FLA	20 HP 27 FLA	20 HP 27 FLA
		600 V AC	15 HP 17 FLA	20 HP 22 FLA	20 HP 22 FLA

Marcaje

Conformidad por prueba superada

Aprobado



DIMENSIONES GENERALES

Montaje en panel trasero

C025... / C032... / C040...

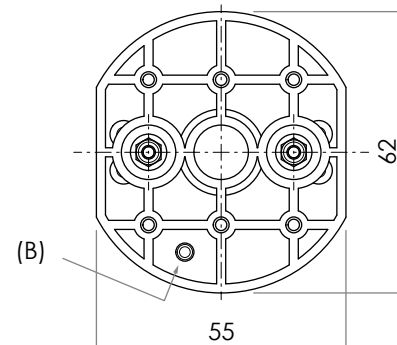
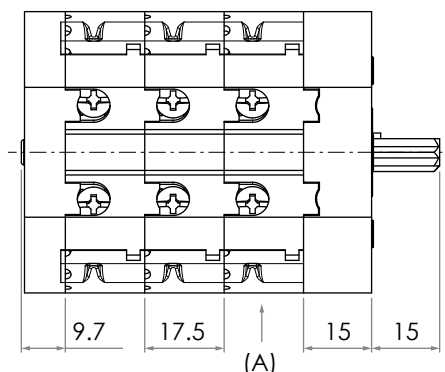
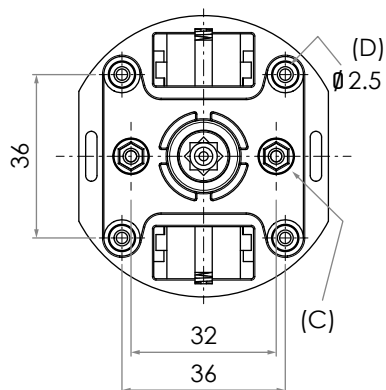

Clase de protección de los terminales IP20

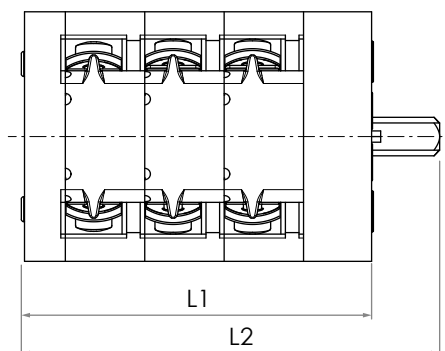

Dimensiones en mm
Ilustraciones NO a escala

- (A) oblea (grosor = 17,5 mm)
- (B) muesca de referencia
- (C) tornillo métrico (M3) orificio de fijación
- (D) tornillo autorroscante (Ø 3,2) orificio de fijación

Algunas dimensiones dependen del número de obleas del interruptor de levas y pueden calcularse con estas fórmulas:

$$L1 \text{ [mm]} = 9.7 + (17.5 \times n. \text{ de obleas}) + 15$$

$$L2 \text{ [mm]} = L1 + 15$$

Ejemplos:

n. de obleas	1	2	3	4	5	6
L1 [mm]	42.2	59.7	77.2	94.7	112.2	129.7
L2 [mm]	57.2	74.7	92.2	109.7	127.2	144.7

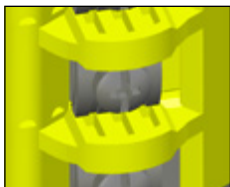
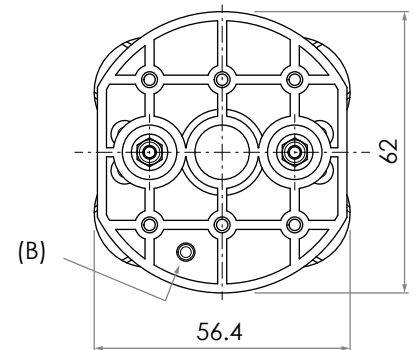
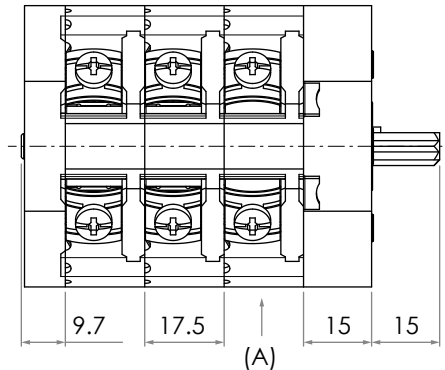
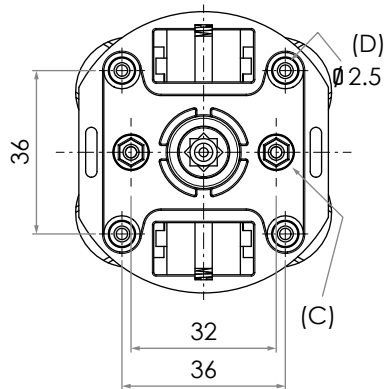

Clase de protección de los terminales IP10

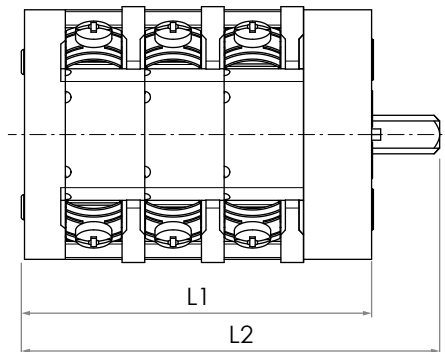

Dimensiones en mm
Ilustraciones NO a escala

- (A) oblea (grosor = 17,5 mm)
- (B) muesca de referencia
- (C) tornillo métrico (M3) orificio de fijación
- (D) tornillo autorroscante (Ø 3,2) orificio de fijación

Algunas dimensiones dependen del número de obleas del interruptor de levas y pueden calcularse con estas fórmulas:

$$L1 \text{ [mm]} = 9.7 + (17.5 \times n. \text{ de obleas}) + 15$$

$$L2 \text{ [mm]} = L1 + 15$$

Ejemplos:

N. de obleas	1	2	3	4	5	6
L1 [mm]	42.2	59.7	77.2	94.7	112.2	129.7
L2 [mm]	57.2	74.7	92.2	109.7	127.2	144.7

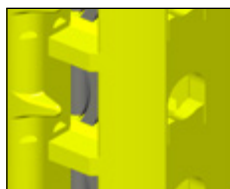
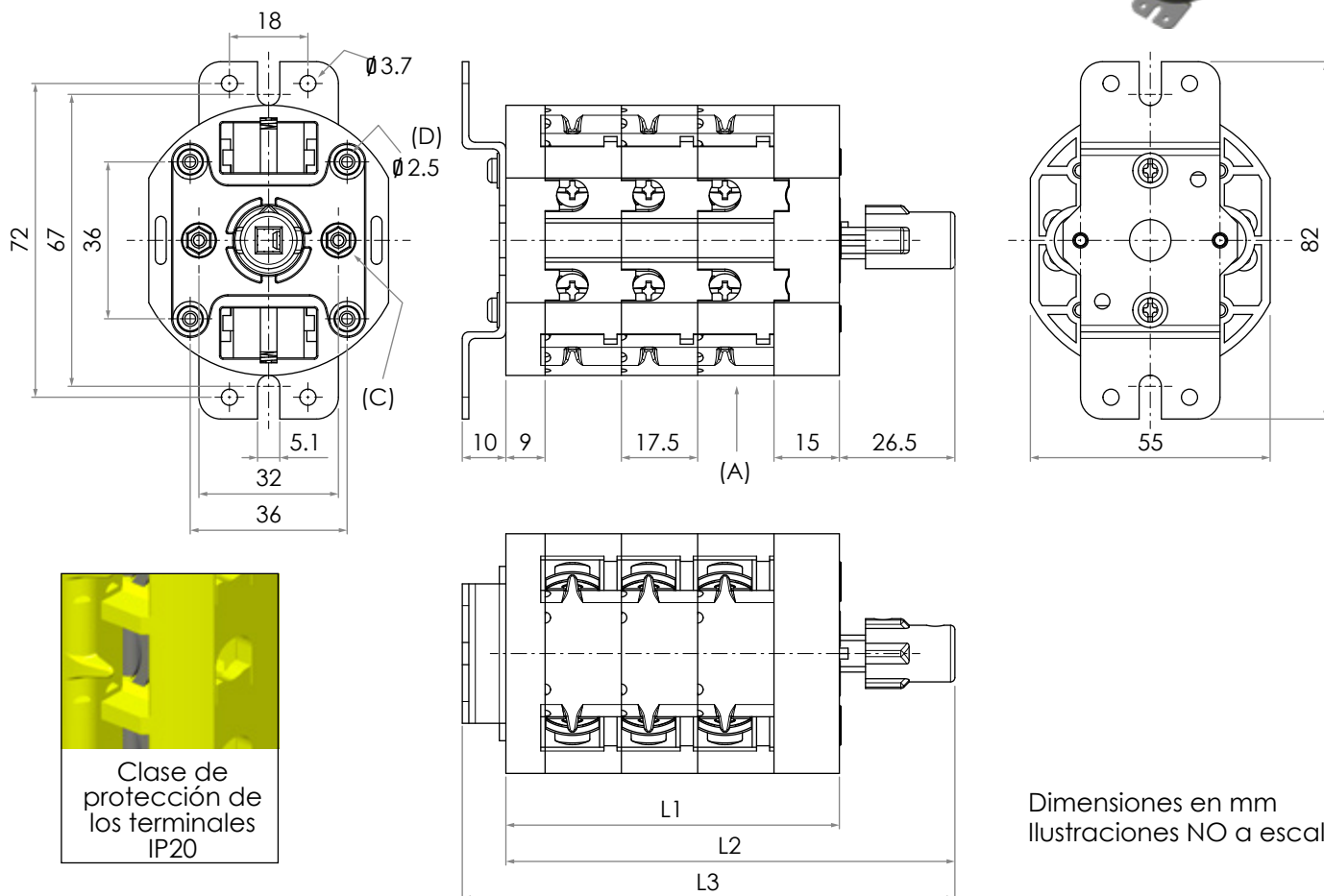

Clase de protección de los terminales IP20

Dimensiones en mm
Ilustraciones NO a escala

- (A) oblea (grosor = 17,5 mm)
- (C) tornillo métrico (M3) orificio de fijación
- (D) tornillo autorroscante (Ø 3,2) orificio de fijación

Algunas dimensiones dependen del número de obleas del interruptor de levas y pueden calcularse con estas fórmulas:

$$L1 \text{ [mm]} = 9 + (17.5 \times n. \text{ de obleas}) + 15$$

$$L2 \text{ [mm]} = L1 + 26.5$$

$$L3 \text{ [mm]} = L2 + 10$$

Ejemplos:

N. de obleas	1	2	3	4	5	6
L1 [mm]	41.5	59	76.5	94	111.5	129
L2 [mm]	68	85.5	103	120.5	138	155.5
L3 [mm]	78	95.5	113	130.5	148	165.5

Montaje en la base

CX25... / CX32... / CX40...

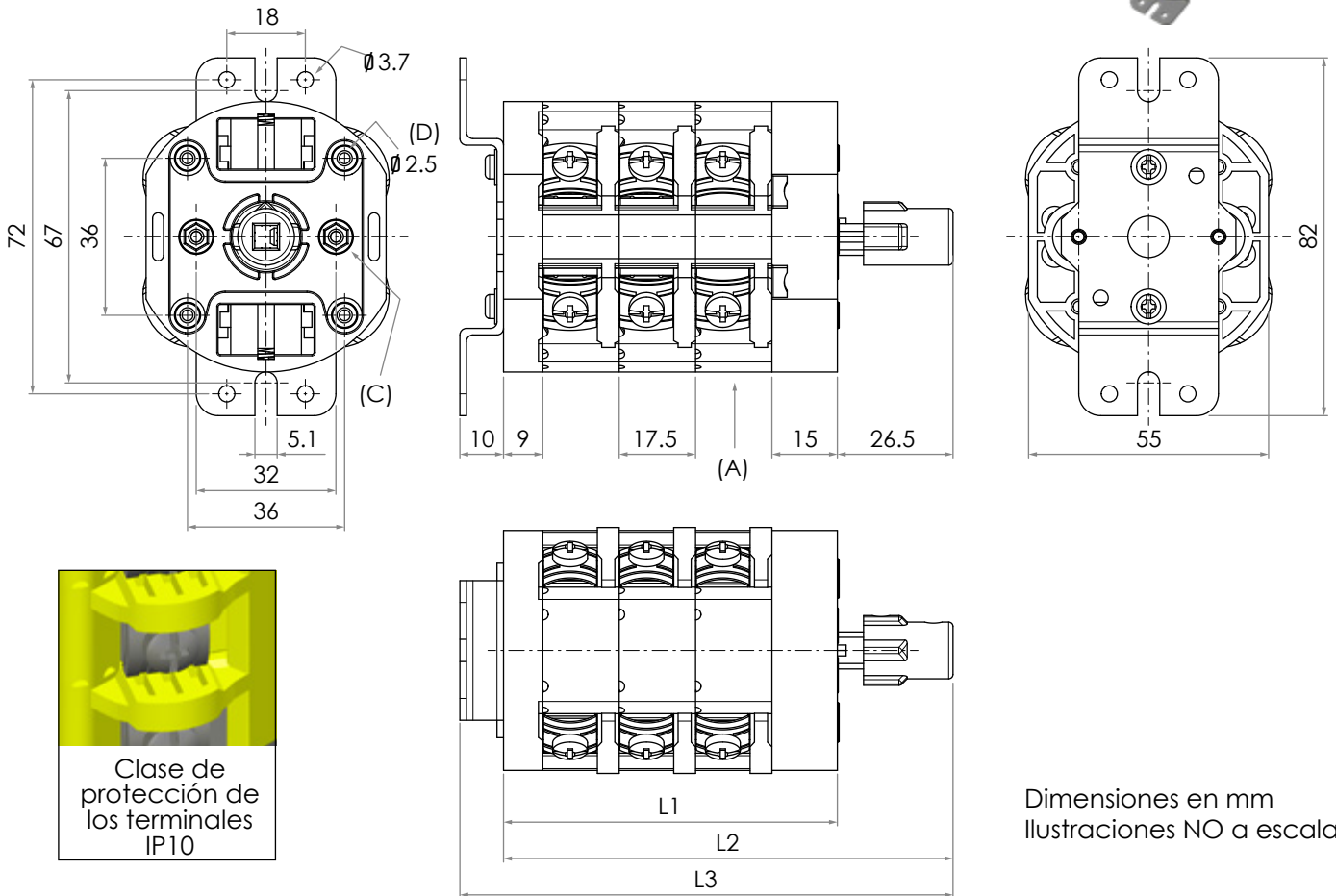

Clase de protección de los terminales IP10

Dimensiones en mm
Ilustraciones NO a escala

- (A) oblea (grosor = 17,5 mm)
- (C) tornillo métrico (M3) orificio de fijación
- (D) tornillo autorroscante ($\varnothing 3,2$) orificio de fijación

Algunas dimensiones dependen del número de obleas del interruptor de levas y pueden calcularse con estas fórmulas:

$$L1 \text{ [mm]} = 9 + (17.5 \times n. \text{ de obleas}) + 15$$

$$L2 \text{ [mm]} = L1 + 26.5$$

$$L3 \text{ [mm]} = L2 + 10$$

Ejemplos:

N. de obleas	1	2	3	4	5	6
L1 [mm]	41.5	59	76.5	94	111.5	129
L2 [mm]	68	85.5	103	120.5	138	155.5
L3 [mm]	78	95.5	113	130.5	148	165.5

ESQUEMAS ELÉCTRICOS

Patrón de comprobación de códigos

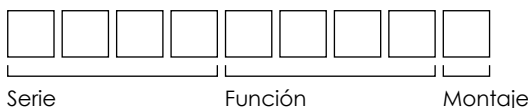

Ejemplo: interruptor de leva en catálogo
Ejemplo: interruptor de leva NO en catálogo

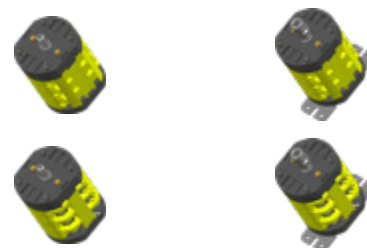

C025 / CX25
C032 / CX32
C040 / CX40

C025 / CX25
C032 / CX32
C040 / CX40

Función	N. de obleas	R	B
Interruptores ON-OFF 0-1 p.10			
0001 Interruptor ON-OFF 1 polo	1	x	-
0002 Interruptor ON-OFF 2 polos	1	x	x
0003 Interruptor ON-OFF 3 polos	2	x	x
0004 Interruptor ON-OFF 4 polos	2	x	x
0005 Interruptor ON-OFF 5 polos	3	x	-
0006 Interruptor ON-OFF 6 polos	3	x	x
0007 Interruptor ON-OFF 3 polos con retorno a cero por muelle	2	x	-
Conmutadores 1-0-2 p.10			
0008 Conmutador 1 polo	1	x	x
0009 Conmutador 2 polos	2	x	x
0010 Conmutador 3 polos	3	x	x
0011 Conmutador 4 polos	4	x	x
Interruptores de motor p.11			
0012 Interruptor inversor 3 polos	3	x	-
0013 Interruptor inversor de 3 polos con retorno a cero por muelle	3	x	-
0014 Interruptor de dos velocid. con cambio de polos Dahlander	4	x	-
0015 Interruptor de arranque estrella-triángulo	4	x	-
0016 Interruptor inversor monofásico con corte centrífugo	3	x	-
0031 Interruptor de 2 velocid. de cambio de polo revers.-dahlander	6	x	-
Interruptores escalonados p.12			
0025 Interruptor escalonado 1-2 posiciones sin cero 1 polo	1	x	-
0026 Interruptor escalonado 1-2 posiciones sin cero 2 polos	2	x	-
0027 Interruptor escalonado 1-2 posiciones sin cero 3 polos	3	x	-
0038 Interruptor escalonado 1-2-3 posiciones sin cero 1 polo	2	x	-
0039 Interruptor escalonado 1-2-3 posiciones sin cero 2 polos	3	x	-
0040 Interruptor escalonado 1-2-3 posiciones sin cero 3 polos	5	x	-
0041 Interruptor escalonado 1-2-3-4 posiciones sin cero 1 polo	2	x	-
0042 Interruptor escalonado 1-2-3-4 posiciones sin cero 2 polos	4	x	-
0043 Interruptor escalonado 1-2-3-4 posiciones sin cero 3 polos	6	x	-
0028 Interruptor escalonado 0-1-2 posiciones con cero 1 polo	1	x	-
0032 Interruptor escalonado 0-1-2 posiciones con cero 2 polos	2	x	-
0033 Interruptor escalonado 0-1-2 posiciones con cero 3 polos	3	x	-
0029 Interruptor escalonado 0-1-2-3 posiciones con cero 1 polo	2	x	-
0034 Interruptor escalonado 0-1-2-3 posiciones con cero 2 polos	3	x	-
0035 Interruptor escalonado 0-1-2-3 posiciones con cero 3 polos	5	x	-
0030 Interruptor escalonado 0-1-2-3-4 posiciones con cero 1 polo	2	x	-
0036 Interruptor escalonado 0-1-2-3-4 posiciones con cero 2 polos	4	x	-
0037 Interruptor escalonado 0-1-2-3-4 posiciones con cero 3 polos	6	x	-

Interruptores ON-OFF 0-1

0001 • 1 polo

0002 • 2 polos

0003 • 3 polos

0004 • 4 polos

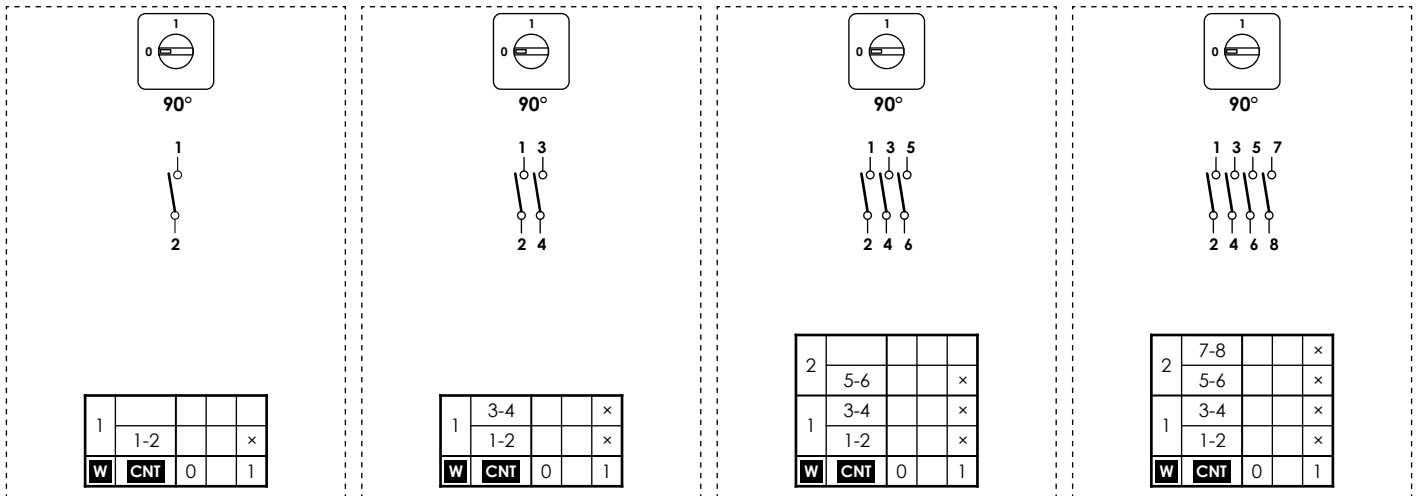

0005 • 5 polos

0006 • 6 polos

0007 • 3 polos con retorno a cero por muelle

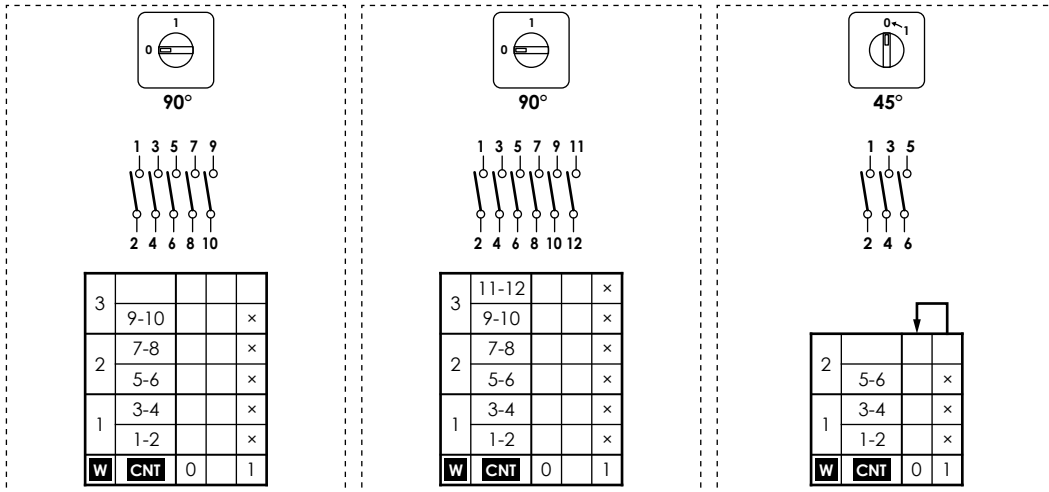

Changeover switches 1-0-2

0008 • 1 polo

0009 • 2 polos

0010 • 3 polos

0011 • 4 polos

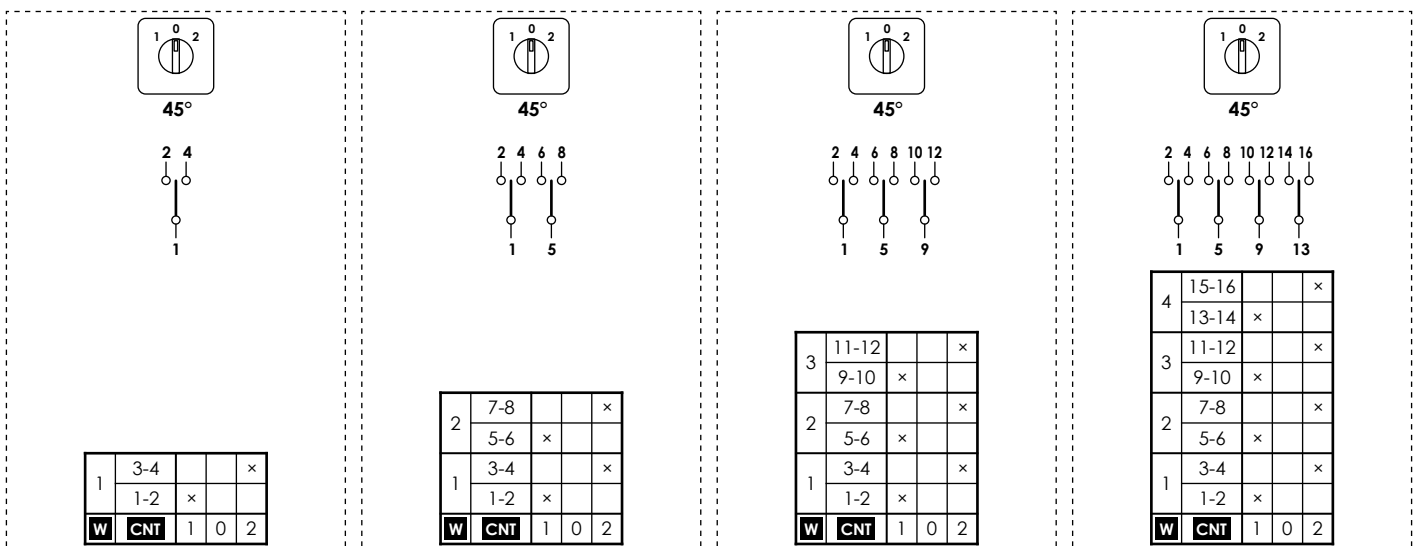

Interruptores de motor

1/1

0012 • Interruptor inversor 3 polos



45°

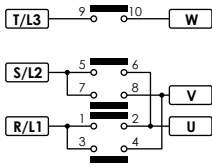
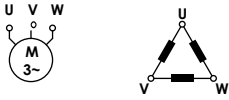
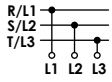

3				
	9-10	x		x
2		7-8	x	
		5-6		x
1		3-4		x
		1-2	x	
W	CNT	1	0	2

0013 • Interruptor inversor de 3 polos con retorno a cero por muelle



45°

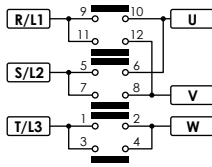
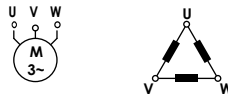
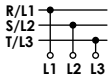

3				
	11-12			x
	9-10	x		
2		7-8	x	
		5-6		x
1		3-4		x
		1-2	x	
W	CNT	1	0	2

0014 • Interruptor de dos velocidades con cambio de polos Dahlander



45°

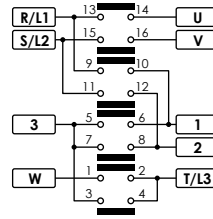
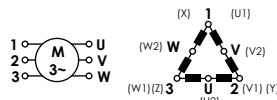
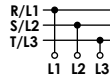

4	15-16			x
	13-14			x
3		11-12	x	
		9-10	x	
2		7-8		x
		5-6		x
1		3-4	x	
		1-2	x	
W	CNT	1	0	2

0015 • Interruptor de arranque Estrella-Delta



60°

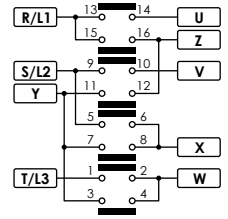
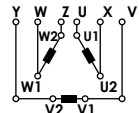
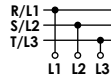

4	15-16			x
	13-14		x	x
3		11-12	x	
		9-10	x	x
2		7-8		x
		5-6		x
1		3-4		x
		1-2	x	x
W	CNT	1	Y	Δ

0016 • Interruptor inversor monofásico con corte centrífugo



45°

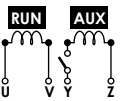
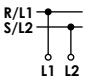

RUN Enrollamiento
AUX Bobinado auxiliar

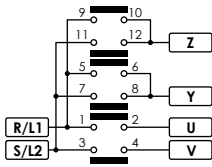

3				
	11-12	x		
	9-10			x
2		7-8		
		5-6	x	
1		3-4	x	x
		1-2	x	x
W	CNT	1	0	2

0031 • Interruptor de dos velocidades con cambio de polos Dahlander inversor



45°

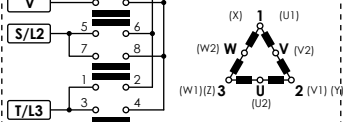
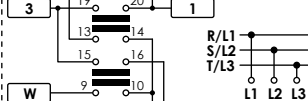
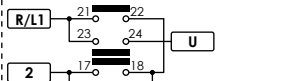

6	23-24	x				x		
	21-22		x		x			
5		19-20	x			x		
		17-18	x			x		
4		15-16		x	x			
		13-14		x	x			
3		11-12	x			x		
		9-10	x			x		
2		7-8			x	x		
		5-6	x	x				
1		3-4	x	x				
		1-2			x	x		
W	CNT	2	0	1	0	1	0	2

Interruptores escalonados

1/3

0025 • Interruptor escalonado 1-2 posiciones sin cero 1 polo

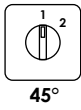

1	3-4		x
	1-2	x	
W	CNT	1	2

0026 • Interruptor escalonado 1-2 posiciones sin cero 2 polos

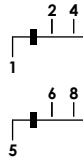
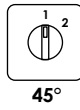

2	7-8		x
	5-6	x	
1	3-4		x
	1-2	x	
W	CNT	1	2

0027 • Interruptor escalonado 1-2 posiciones sin cero 3 polos

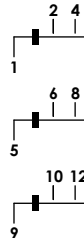
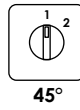

3	11-12		x
	9-10	x	
2	7-8		x
	5-6	x	
1	3-4		x
	1-2	x	
W	CNT	1	2

0038 • Interruptor escalonado 1-2-3 posiciones sin cero 1 polo

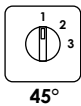

2	5-6			x
1	3-4		x	
	1-2	x		
W	CNT	1	2	3

0039 • Interruptor escalonado 1-2-3 posiciones sin cero 2 polos

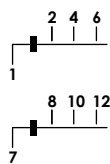
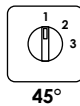

3	11-12			x
	9-10	x		
2	7-8		x	
	5-6			x
1	3-4		x	
	1-2	x		
W	CNT	1	2	3

0040 • Interruptor escalonado 1-2-3 posiciones sin cero 3 polos

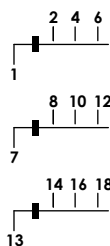
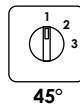

5	17-18			x
4	15-16		x	
	13-14	x		
3	11-12			x
	9-10	x		
2	7-8		x	
	5-6			x
1	3-4		x	
	1-2	x		
W	CNT	1	2	3

Interruptores escalonados

2/3

0041 • Interruptor escalonado 1-2-3-4 posiciones sin cero 1 polo

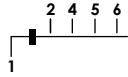
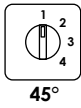

2	7-8			x	
	5-6		x		
1	3-4	x			
	1-2	x			
W	CNT	1	2	3	4

0042 • Interruptor escalonado 1-2-3-4 posiciones sin cero 2 polos

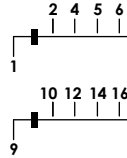
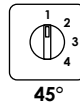

4	15-16			x	
	13-14		x		
3	11-12	x			
	9-10	x			
2	7-8			x	
	5-6		x		
1	3-4	x			
	1-2	x			
W	CNT	1	2	3	4

0043 • Interruptor escalonado 1-2-3-4 posiciones sin cero 3 polos

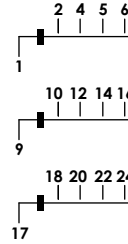
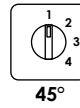

6	23-24			x	
	21-22		x		
5	19-20	x			
	17-18	x			
4	15-16			x	
	13-14		x		
3	11-12	x			
	9-10	x			
2	7-8			x	
	5-6		x		
1	3-4	x			
	1-2	x			
W	CNT	1	2	3	4

0028 • Interruptor escalonado 0-1-2 posiciones con cero 1 polo

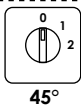

1	3-4		x	
	1-2	x		
W	CNT	0	1	2

0032 • Interruptor escalonado 0-1-2 posiciones con cero 2 polos

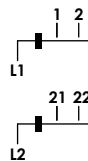
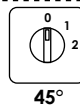

2	7-8		x	
	5-6	x		
1	3-4		x	
	1-2	x		
W	CNT	0	1	2

0033 • Interruptor escalonado 0-1-2 posiciones con cero 3 polos

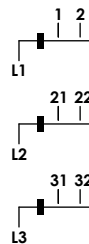
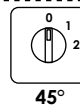

3	11-12		x	
	9-10	x		
2	7-8		x	
	5-6	x		
1	3-4		x	
	1-2	x		
W	CNT	0	1	2

Interruptores escalonados

3/3

0029 • Interruptor escalonado 0-1-2-3 posiciones con cero 1 polo

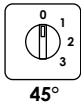

45°

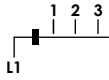

2	7-8			x	
	5-6	x			
1	3-4			x	
	1-2		x		
W	CNT	0	1	2	3

0034 • Interruptor escalonado 0-1-2-3 posiciones con cero 2 polos

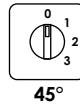

45°

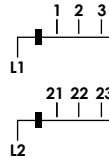

3	11-12			x	
	9-10	x			
2	7-8			x	
	5-6		x		
1	3-4			x	
	1-2	x			
W	CNT	0	1	2	3

0035 • Interruptor escalonado 0-1-2-3 posiciones con cero 3 polos

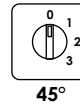

45°

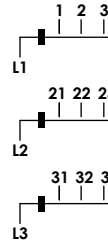

5	19-20			x	
4	15-16			x	
	13-14	x			
3	11-12			x	
	9-10	x			
2	7-8			x	
	5-6		x		
1	3-4			x	
	1-2	x			
W	CNT	0	1	2	3

0030 • Interruptor escalonado 0-1-2-3-4 posiciones con cero 1 polo

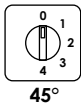

45°

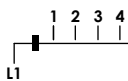

2	7-8			x		
	5-6	x				
1	3-4			x		
	1-2		x			
W	CNT	0	1	2	3	4

0036 • Interruptor escalonado 0-1-2-3-4 posiciones con cero 2 polos

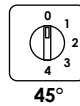

45°

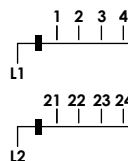

4	15-16			x		
	13-14	x				
3	11-12			x		
	9-10		x			
2	7-8			x		
	5-6	x				
1	3-4			x		
	1-2	x				
W	CNT	0	1	2	3	4

0037 • Interruptor escalonado 0-1-2-3-4 posiciones con cero 3 polos

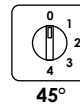

45°

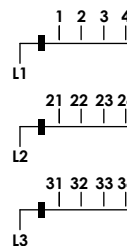













6	23-24			x		
	21-22	x				
5	19-20			x		
	17-18		x			
4	15-16			x		
	13-14	x				
3	11-12			x		
	9-10		x			
2	7-8			x		
	5-6	x				
1	3-4			x		
	1-2	x				
W	CNT	0	1	2	3	4

ACTUADORES

Matriz de interruptores / Actuadores de leva

Compruebe la «Matriz de esquemas de funcionamiento» (p.16) para identificar el esquema de funcionamiento disponible para cada operador.



Series y tamaños		C025 C032 C040	CX25 CX32 CX40	C025 C032 C040	CX25 CX32 CX40
Clase de protección de los terminales		IP20	IP10	IP20	IP10
Tipo de montaje		R		B	
48x48	Gris/Negro	-	-		-
tornillo Ø 22	IP65 IP65	-	-	-	095/...
48x48	Amarillo/Rojo	-	-		-
tornillo Ø 22	IP65 IP65	-	-	-	070/...
48x48	Gris/Negro candado en 0		-		-
tornillo Ø 22	IP65 / 4-4X IP65 / 4-4X	003/...	-	005/...	077/...
tornillo Ø 22	IP65	-	-	-	-
48x48	Amarillo/Rojo candado en 0		-		-
tornillo Ø 22	IP65 / 4-4X IP65 / 4-4X	004/...	-	006/...	069/...
tornillo Ø 22	IP65	-	-	-	-
64x64	Gris/Negro		-		-
tornillo	IP65	007/...	-	021/...	-
64x64	Amarillo/Rojo		-	-	-
tornillo	IP65	008/...	-	-	-
67x67	Gris/Negro max 3 padlocks		-		-
tornillo Ø 22	IP65 / 4-4X IP65 /	009/...	-	011/...	063/...
tornillo Ø 22	4-4X IP65	-	-	-	-
67x67	Amarillo/Rojo max 3 candados		-		-
tornillo Ø 22	IP65 / 4-4X IP65 /	010/...	-	012/...	064/...
tornillo Ø 22	4-4X IP65	-	-	-	-

Matriz de esquemas de funcionamiento

Ejemplo de código de actuador: 003/0001

	Interruptores ON-OFF 0-1			Conmutadores 1-0-2 / Conmutadores de motor					
003/...	0001	0001-1	0007	0008	0017	0013	0015	0018	0031
004/...	0001	0001-1	0007	0008	0017	0013	0015	0018	0031
005/...	0001	0001-1	-	0008	-	-	-	-	-
006/...	0001	0001-1	-	0008	-	-	-	-	-
007/...	0001	0001-1	0007	0008	-	0013	0015	-	0031
008/...	0001	0001-1	0007	0008	-	-	0015	-	0031
009/...	0001	0001-1	-	0008	0017	0013	0015	0018	0031
010/...	0001	0001-1	0007	0008	0017	0013	0015	0018	0031
011/...	0001	0001-A	-	0008	-	-	-	-	-
012/...	0001	0001-2	-	0008	-	-	-	-	-
021/...	0001	-	-	0008	-	-	-	-	-
063/...	0001	0001-1	-	0008	-	-	-	-	-
064/...	0001	0001-1	-	0008	-	-	-	-	-
069/...	0001	-	-	0008	-	-	-	-	-
070/...	0001	-	-	0008	-	-	-	-	-
077/...	0001	-	-	0008	-	-	-	-	-
095/...	0001	-	-	0008	-	-	-	-	-

	Interruptores escalonados					
003/...	-	-	-	-	-	-
004/...	-	-	-	-	-	-
005/...	-	-	-	-	-	-
006/...	-	-	-	-	-	-
007/...	0025	0028	0038	0029	0041	0030
008/...	-	-	-	-	-	-
009/...	-	-	-	-	-	-
010/...	-	-	-	-	-	-
011/...	-	-	-	-	-	-
012/...	-	-	-	-	-	-
021/...	-	-	-	-	-	-
063/...	-	-	-	-	-	-
064/...	-	-	-	-	-	-
069/...	-	-	-	-	-	-
070/...	-	-	-	-	-	-
077/...	-	-	-	-	-	-
095/...	-	-	-	-	-	-